

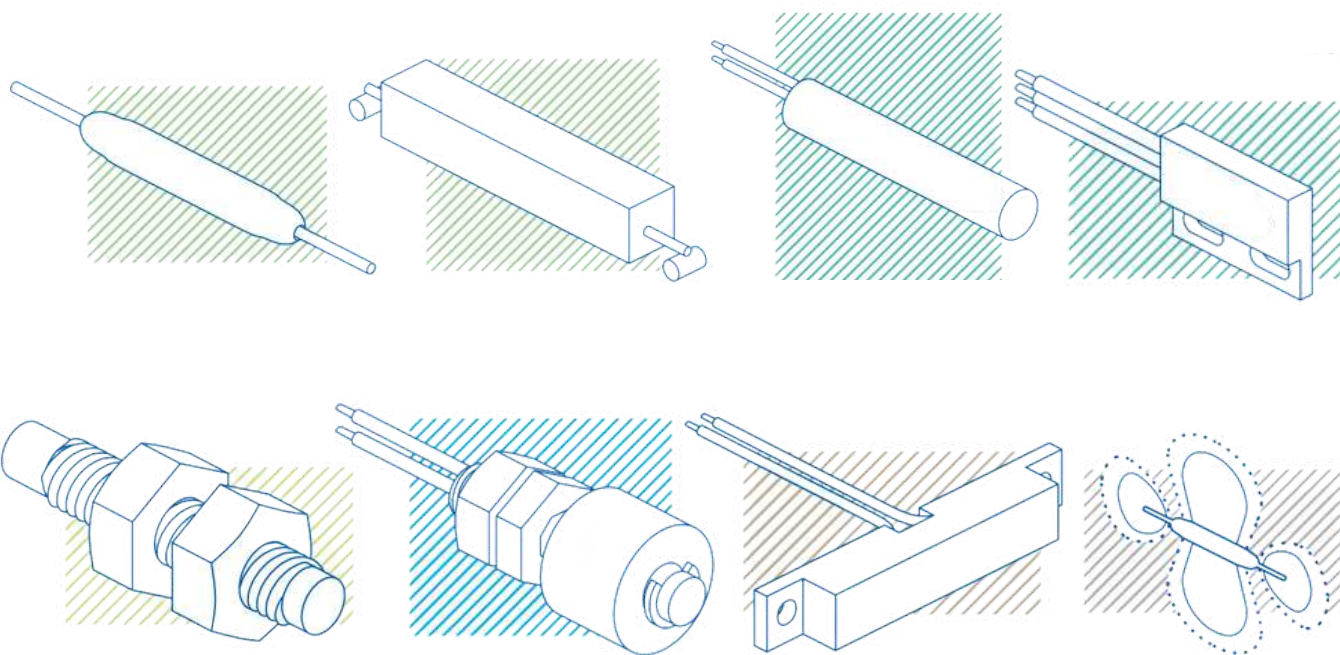

NOUVEAU PARTENARIAT

Spécialiste interrupteurs électromagnétiques

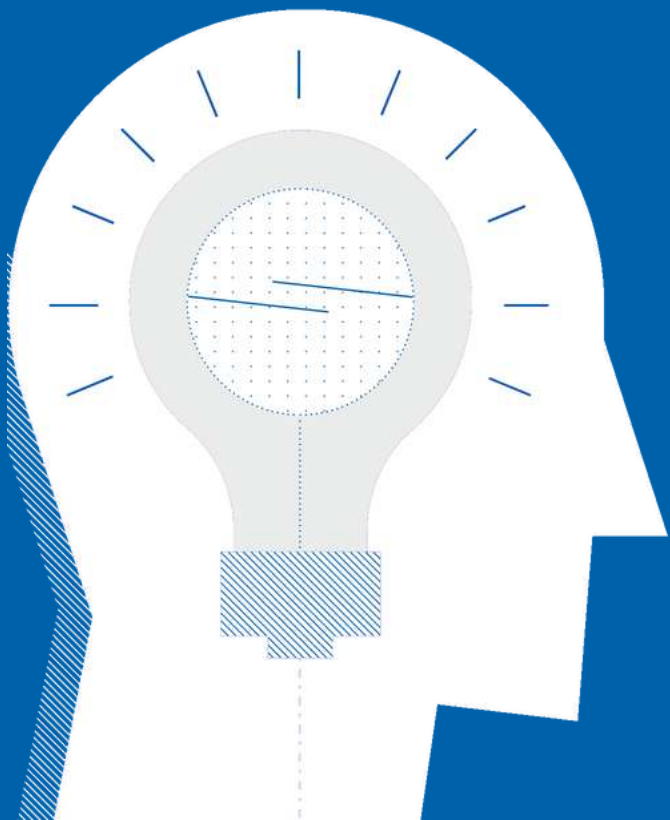

PIC
SWITCHING THE SMART WAY

INTERRUPTEURS REED

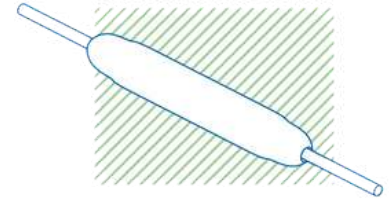

Différentes tailles,
caractéristiques électriques
et formes pour différentes
applications.



INTERRUPTEURS REED SMD

Prêt pour les procédés TMS
comme le pick and place
et le soudage automatisé
dans les fours de refusion.

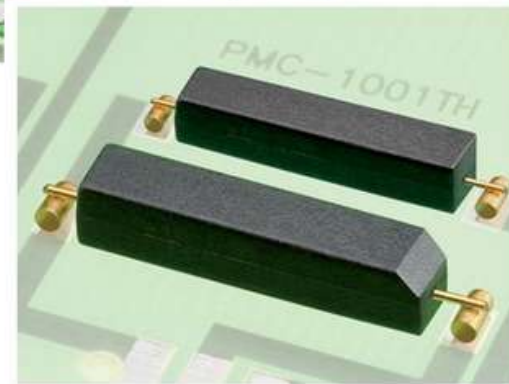
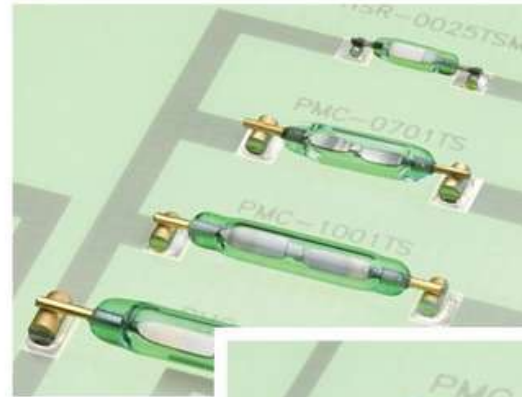
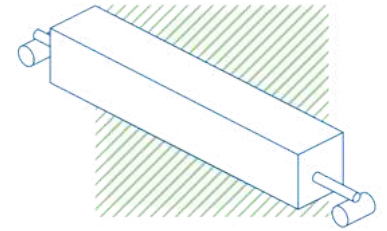



CHAÎNES INTERRUPTEURS REED

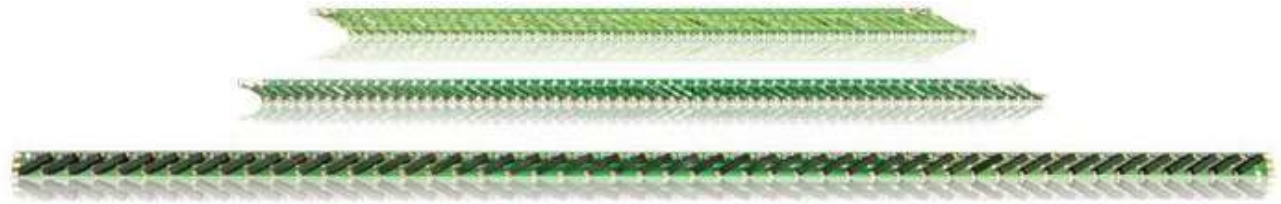
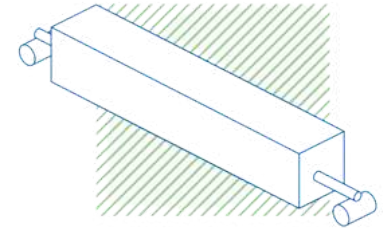

Détection individuelle du niveau linéaire par mesure de la résistance.

CAPTEURS MAGNÉTIQUES

Différents types de boîtier avec câble et connecteur, différentes gammes de sensibilité, classé IP 67.

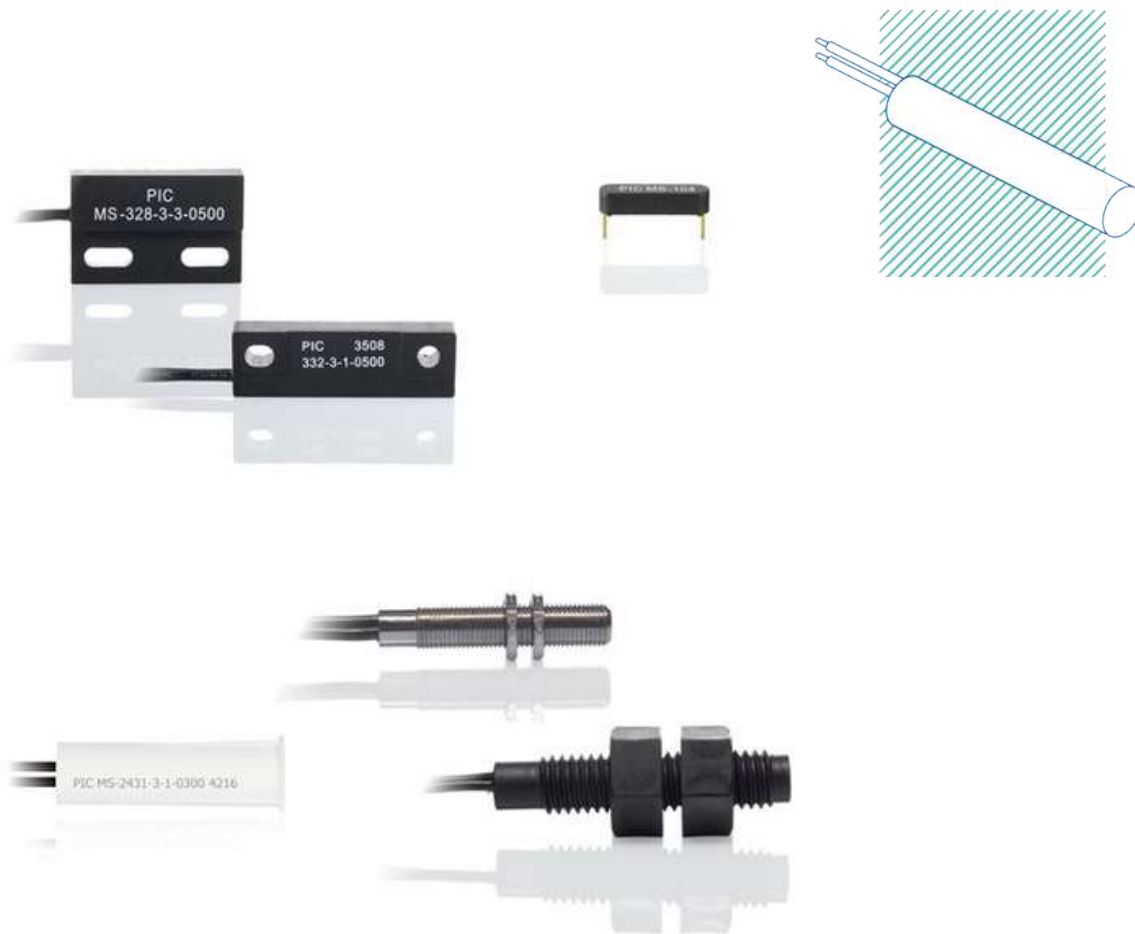

Technologie différente
(effet Hall) pour les hautes
fréquences de
commutation supérieures
à 500 Hz.

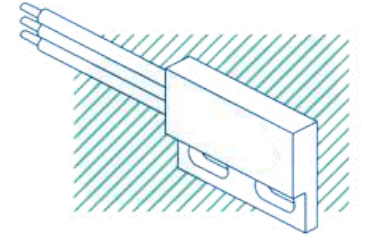

Conception et
approvisionnement
d'aimants personnalisable.
Une combinaison sûre
et fiable !

AIMANTS

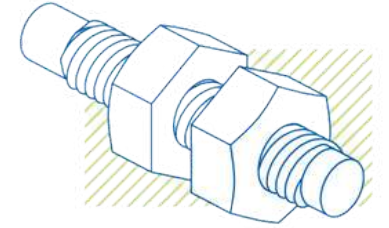



CAPTEURS DE NIVEAU

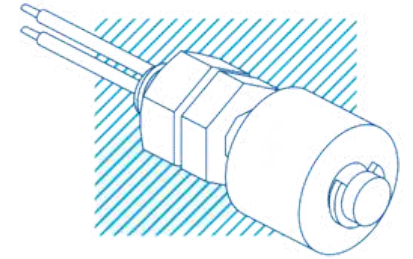

PP, PA et acier inoxydable pour différentes applications, y compris le contact alimentaire avec l'approbation de la FDA.



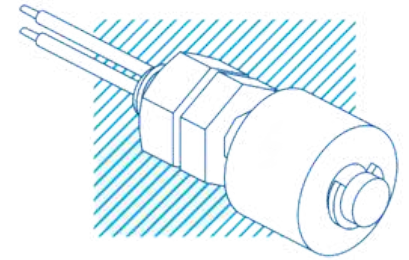

Aimants flottants pour la
détection du niveau
individuel.